



SYSTO·TEC

Alle Möbel von PALMBERG garantieren eine 100% fugenlose Kantenverarbeitung durch Lasertechnologie auf höchstem Niveau. Unsere Produktion unterliegt dabei den strengen Anforderungen des Qualitätsmanagements ISO 9001:2008, dem Umweltmanagement ISO 14001:2004 und der EG-Ökoauditverordnung.

Mit PALMBERG freuen Sie sich aufs Büro!

All pieces of furniture from PALMBERG guarantee 100% joint-less edge processing by means of laser technology at the highest stage. Our production is subject to the strict requirements of the Quality Management ISO 9001:2008, the Environmental Management ISO 14001:2004 and the EC Eco-Management and Audit Scheme.

With PALMBERG you're looking forward to the office!

Alle meubels van PALMBERG garanderen een 100% voegloze kantverbinding door lasertechnologie van het hoogste niveau. Wij produceren volgens de strenge eisen van het kwaliteitsmanagement ISO 9001:2008, het milieumanagement ISO 14001:2004 en de EG Ecoauditverordening.

Met PALMBERG is het plezierig werken!





Unser Klassiker · Our classic · Onze klassieker



Ein System – zwei Anmutungen

Ob Rundrohr oder Quadratrohr, verschweißte Seitenteile sorgen bei SYSTO-TEC zukünftig für noch mehr Stabilität bei der Arbeit. Konstruktive Elemente, wie die am Rahmen befestigten Verbindungsklammern, verleihen dem System dabei eine besondere Optik, ohne dabei aufdringlich zu sein.

One System – Two Impressions

Whether round tube or square tube, welded laterals will bring even more stability at work with SYSTO-TEC. Constructional elements, such as connecting clamps mounted at the frame, give the system a special, unpretentious appearance.

Eén systeem – twee indrukken

Ronde of vierkante poten, gelaste zijdelen bij SYSTO-TEC zorgen in de toekomst voor nog meer stabiliteit tijdens het werk. Constructieve elementen, zoals de aan het frame bevestigde verbindingsklemmen, geven het systeem een bijzondere look zonder dat het daarbij in het oog springend is.







Formvollendet und funktional!
Perfect in form and function!
Perfect en functioneel!

SYSTO-TEC ist ein Teamplayer, der durch viele sinnvolle Zusatzkomponenten die kommunikative Büroarbeit unterstützt. Das Tischsystem besticht durch den klaren Aufbau der Grundkomponenten und steht dabei auf 60 mm starken Rundrohren. Damit Sie verspannungsfrei arbeiten können, ist es möglich die Tischhöhe über die herausdrehbaren Stellelemente von 680 auf 760 mm zu verstellen.

SYSTO-TEC is a team player that supports communicative office work by a lot of useful additional elements. The desk system captivates with the clear construction of the basic components and stands on 60 mm circular tubes. It is possible to adjust the table height from 680 to 760 mm via twistable standing elements so that you are able to work free of tensions.

SYSTO-TEC is een teamplayer, die door vele nuttige extra componenten de communicatie in de kantooromgeving ondersteunt. Het bureausysteem is uiterest stabiel door de eenvoudige constructie van de basiscomponenten en staat daarbij op 60 mm sterke ronde poten. Om er voor te zorgen dat u ontspannen kunt werken, is het mogelijk om de bureauhoogte door middel van uitdraaibare steldoppen van 680 tot 760 mm te verstellen.

vertikale Kabelführung · vertical cable
conduit · verticale kabelgeleiding



SYSTO-TEC | 8





Chrom matt · chrome matt · chroom mat Schwarz · black · zwart

Höheneinstellung durch Stellelemente
Height adjustment by standing elements
Instelbare hoogte door steldoppen





Für die richtige Entscheidung am Arbeitsplatz!
For the right decision in the workplace!
Voor de juiste beslissing op de werkplek.





Ergonomisch und variabel bleibt man bei SYSTO-TEC auch mit der Rohr-in-Rohr Variante. Diese Gestellform ermöglicht dem Nutzer eine Höheneinstellung zwischen 650 und 850 mm. In Verbindung mit Sideboards der Serie SELECT werden so aus Ihren Räumen inspirierende Arbeitswelten.

Also the tube-in-tube variant keeps you ergonomic and variable with SYSTO-TEC. This type of frame allows the user a height adjustment between 650 and 850 mm. In combination with sideboards of the SELECT series, your rooms are becoming inspiring working worlds.

Ergonomisch en flexibel blijft men ook met de SYSTO-TEC buis-in-buis oplossing. Dit onderstel maakt het voor de gebruiker mogelijk om een hoogte tussen 650 en 850 mm in te stellen. In combinatie met sideboards van de serie SELECT worden uw ruimtes zo inspirerende werkplekken.



Qualität, die ineinander greift!

Quality that interlocks!

Kwaliteit, die verbindt!





SYSTO-TEC | 14

Furnier Amerikanische Kirsche
Veneer American Cherry
Finoer amerikaanse kersen



Neben seiner enormen Stabilität bietet SYSTO-TEC vielfältige Lösungen für den Büroalltag. Ob konzentrierte Einzelarbeit, kommunikative Teamarbeit oder große Konferenzlösung, bei SYSTO-TEC wird das sachlich-elegante Erscheinungsbild des Tischsystems immer erkennbar beibehalten.

Along with its enormous stability, SYSTO-TEC offers a wide range of solutions for the daily office life. Whether focused individual work, communicative teamwork or large-scale conference solution, SYSTO-TEC always recognizably maintains the functional-elegant appearance of the desk system.

Naast zijn enorme stabiliteit biedt SYSTO-TEC veelzijdige oplossingen voor het leven op kantoor. Of het gaat om geconcentreerd werk, communicatieve samenwerking of grote conferenties, bij SYSTO-TEC wordt de zakelijk-elegante uitstraling van de meubelsysteem altijd herkenbaar gehandhaafd.







Arbeit im Quadrat

Die Vielfalt des Systems SYSTO-TEC ermöglicht es Ihnen, Tischbeine mit quadratischem Querschnitt auszuwählen. Die Quadrat-Rohr-Variante vermittelt dabei eine völlig neue Optik, gradlinig, stabil und klar.

Work in a Square

The diversity of the SYSTO-TEC system allows you to select table legs with a square cross-section. The square-tube-variant is conveying an entirely new appearance in this way, straight-line, stable and clear.

Rechtlĳnig Werken

Dankzij de diversiteit van het SYSTO-TEC systeem is het mogelijk om tafelpoten met een vierkante poot te kiezen. De vierkante poot-variant brengt een volledig nieuwe look; rechtlĳnig en stabiel.



Durch die klare konzeptionelle Ausrichtung passt sich SYSTO-TEC ohne Probleme an Ihre individuellen Arbeitsbedingungen an. Das stabile Tischsystem lässt sich dabei durch zusätzliche Adaptionen für den jeweiligen Funktionsbereich optimal erweitern.

By its clear conceptual approach, SYSTO-TEC easily adapts itself to your individual working conditions. The stable desk system can be optimally extended by additional adaptations for the respective functional area.

Door de duidelijke conceptuele geheel, past SYSTO-TEC zich zonder problemen aan uw individuele werkwijze aan. Het stabiele meubelsysteem laat zich dankzij extra aanpassingen voor elke gewenste functie optimaal uitbreiden.



SYSTO-TEC | 18



Schiebeplattenbeschlag
Sliding plate fitting
Schuifbladbeslag



CPU-Halter
CPU-Holder
PC-houder

Offen für Ihre Wünsche
Open to your requests
Open voor uw wensen





Sachlich, elegant und zeitgemäß!
Functional, elegant and contemporary!
Zakelijk, elegant en eigentijds!



SYSTO-TEC überzeugt alle, die Wert auf Qualität, Optik und eine zeitgemäße Bürolösung legen. Die perfekte Kombination aus Form und Funktion bietet dabei die Grundlage für eine professionelle und motivierende Arbeitsatmosphäre.



21 | SYSTO-TEC

SYSTO-TEC convinces anyone who attaches importance to quality, visual appearance and a contemporary office solution. The perfect combination of form and function provides the basis for a professional and motivating working atmosphere.

SYSTO-TEC overtuigt iedereen die waarde hecht aan kwaliteit, uitstraling en een eigentijdse kantooroplossing. De perfecte combinatie van vorm en functie biedt de basis voor een professionele en motiverende werkomgeving.

Erfolgreiche Gespräche sind planbar!
Successful meetings are predictable!
Succesvolle gesprekken worden voorspeld!



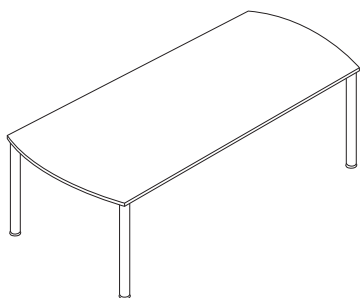
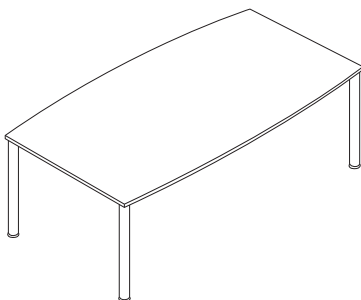
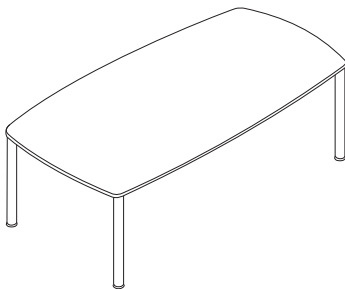
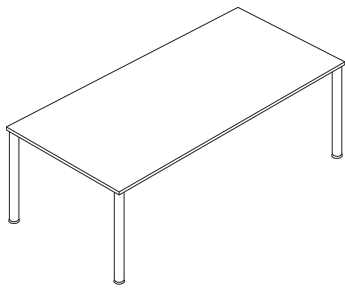

SYSTO-TEC bietet für jede Kommunikation die passende Lösung. Egal, welche Tischform Sie wählen, SYSTO-TEC ermöglicht eine nutzergerechte Anpassung für Ihre Gespräche.

SYSTO-TEC offers the suitable solution for each situation. Whatever shape of table you choose, SYSTO-TEC permits a user-oriented adjustment for your discussions.

SYSTO-TEC biedt voor elke vorm van communicatie de passende oplossing. Ongeacht welke tafelvorm u kiest, SYSTO-TEC maakt gebruiksvriendelijke aanpassingen voor uw gesprek mogelijk.



Volldekore · Decors · Voldecors 19 / 25 mm



Ahorn · Maple · ahorn



Akazie · Acacia · acacia



Eiche natur · Natural oak · eiken natuur



Buche gedämpft · Beech muted · gedempt beuken



Birnbaum · Pear · peren



Toskan. Nussbaum · Tuscan walnut · toskaans noten



Teak Rubin · Teak ruby · teak rubin



Merano



Nussbaum natur · Natural walnut · noten natuur



Malaga Eiche · Malaga oak · malaga eik



Zebrano



Superweiß · Super white · superwit



Grau perl · Grey pearl · grijs parel

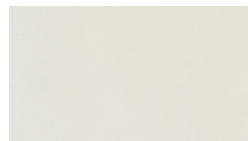

Hanf perl · Hemp pearl · hanf parel



Sandbeige · Sand beige · zandbeige

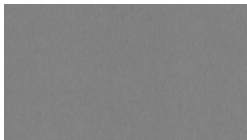

Alu geschliffen · Aluminium polished · geslepen aluminium



Lava



Anthrazit perl · Anthracite pearl · antraciet parel



Vulkanschwarz · Volcano black · vulkaan zwart



Olivgrün · Olive green · olijfgroen

Furnier · Veneers · Fineer 25 mm



Ahorn · Maple · ahorn



Birnbaum · Pear · peren



Buche · Beech · beuken



Amerik. Kirsche · American cherry · Amerikaanse kersen



Eiche natur · Natural oak · eiken natuur



Nussbaum natur · Natural walnut · noten natuur

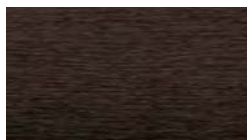

Wenge · Wenge · wengé

Kompaktschichtstoff · Lamine · Volkern 12 mm



Ahorn · Maple · ahorn



Buche · Beech · beuken



Birnbaum · Pear · peren

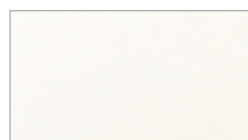

Superweiß · Super white · superwit



Merano

Erfahrungsgemäß können Druckfarben nicht die Brillianz der Dekor- und Gestellfarben wiedergeben. Gern wird Ihr Händler Ihnen Originalmuster vorlegen.

Experience shows that the colors presented do not display the brilliance of the real decor and frame finishes. Your dealer will be pleased to show you original samples.

Uit ervaring blijkt dat geprinte kleuren niet de glans van de kleuren van de decors en onderstellen kunnen reproduceren. Uw dealer laat u graag de originele stalen zien.

Gestell, Schiebepplatten, Aufsatzblenden und Kabelkanal

Frame, sliding plates, attachment surrounds and cable duct · Onderstel, schuifbladen, opzetwanden en kabelkanaal

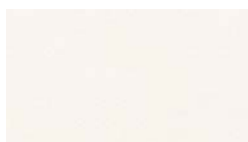

Weiß struktur · White structure · wit structuur



Weißaluminium · White aluminium · wit aluminium



Anthrazit Struktur
Anthracite structure
antraciet structuur

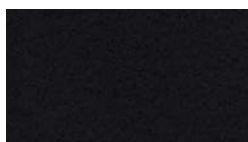

Schwarz struktur · Black structure · zwart structuur

Außenrohr · Outer tube · Buitenste poot

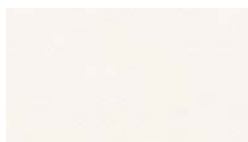

Weiß struktur · White structure · wit structuur



Weißaluminium · White aluminium · wit aluminium



Anthrazit Struktur
Anthracite structure
antraciet structuur



Schwarz struktur · Black structure · zwart structuur



Chrom glanz · Chrome glossy
chrom glans

Fußstopfen · Foot plugs · Steldoppen

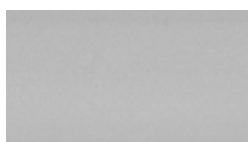

Chrom matt · Chrome matt · chrom mat

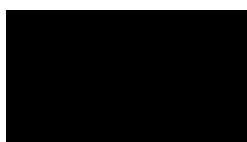

Schwarz RAL 9011 · Black · zwart



Chrom glanz · Chrome glossy
chrom glans

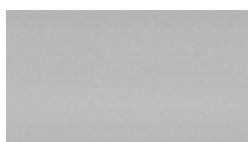

Chrom matt · Chrome matt · chrom mat



Chrom glanz · Chrome glossy
chrom glans

Verbindungsklammern

Connection clamps · Koppelklemmen



PENSUM

Ideen für Entscheidungen Ideas for decisions · Ideeën voor beslissingen



CREW

Neben dem System SYSTO-TEC bietet PALMBERG weitere hochwertige Arbeitsplatzsysteme an. Überzeugen Sie sich auf www.palmberg.de wie vielfältig moderne Büroarbeit sein kann.

Besides the SYSTO-TEC system, PALMBERG offers additional high-quality workplace systems. Find out for yourself at www.palmberg.de how diverse modern office work can be.

Naast het systeem SYSTO-TEC biedt PALMBERG ook andere hoogwaardige werkpleksystemen aan. Overtuigt u zich op www.palmberg.nl of www.palmberg.be, hoe veelzijdig modern kantoorwerk kan zijn.



PALMBERG Büroeinrichtungen + Service GmbH
Am Palmberg 9 · 23923 Schönberg
Tel. +49 38828 38-0 · Fax +49 38828 38-136
info@palmberg.de · www.palmberg.de

PALMBERG (Schweiz) AG
Werkstrasse 17 · 8222 Beringen
Tel. +41 62 888 80 00 · Fax +41 62 888 80 09
info@palmberg.ch · www.palmberg.ch

PALMBERG Büroeinrichtungen + Service GmbH
Rietveldeweg 47 · 5222 AP 's-Hertogenbosch
Tel. +31 411 689522 · Fax +31 411 689479
info@palmberg.nl · www.palmberg.nl

PALMBERG-Produkte werden ausschließlich über autorisierte Fachhändler angeboten, um Ihnen ein Höchstmaß an Service und Bürokompetenz zu gewährleisten. Wenden Sie sich daher an: